

(3) Duct connected-High static pressure type (FDU)

PJG012D022

(a) Indoor unit

- This manual is for installation of an indoor unit and an outdoor air processing unit (FDU-F).
- This manual is for the installation of an indoor unit.
- For electrical wiring work (Indoor), refer to page 195. For remote control installation, refer to page 199. For wireless kit installation, refer to page 370. For electrical wiring work (Outdoor) and refrigerant pipe work installation for outdoor unit, refer to page 211.

The case of FDU-F

- The total connection capacity of the other air conditioning units and the outdoor air processing units must be from 50% to 100% (the total includes the outdoor air processing unit). The connection capacity of the outdoor air processing unit must not exceed 30% of the capacity of the outdoor unit.
- Single outdoor air processing unit can be used alone. The connection capacity of the outdoor air processing unit must be from 50% to 100% of the total capacity of the outdoor unit. Maximum number of outdoor air processing units that can be connected to the outdoor unit is 2units.
- Capacities of the suction air processing units can be calculated with the following formulas.
FDU650FKXE1 = 90, FDU1100FKXE1 = 140

SAFETY PRECAUTIONS

- Read the "SAFETY PRECAUTIONS" carefully first of all and then strictly follow it during the installation work in order to protect yourself.
- The precautionary items mentioned below are distinguished into two levels, **WARNING** and **CAUTION**.
WARNING: Wrong installation would cause serious consequences such as injuries or death.
CAUTION: Wrong installation might cause serious consequences depending on circumstances.
 Both mentions the important items to protect your health and safety so strictly follow them by any means.
- The meanings of "Marks" used here are as shown on the right:
 ○ Never do it under any circumstances. ⚠ Always do it according to the instruction.
- After completing the installation, do commissioning to confirm there are no abnormalities, and explain to the customers about "SAFETY PRECAUTIONS", correct operation method and maintenance method (air filter cleaning, operation method and temperature setting method) with user's manual of this unit. Ask your customers to keep this installation manual together with the user's manual. Also, ask them to hand over the user's manual to the new user when the owner is changed.

WARNING

- **Installation should be performed by the specialist.**
If you install the unit by yourself, it may lead to serious trouble such as water leakage, electric shock, fire, and injury due to overturn of the unit. ⚠
- **Install the system correctly according to these installation manuals.**
Improper installation may cause explosion, injury, water leakage, electric shock, and fire. ⚠
- **Check the density referred by the formula (accordance with ISO5149).**
If the density exceeds the limit density, please consult the dealer and installate the ventilation system. ⚠
- **Use the genuine accessories and the specified parts for installation.**
If parts unspecified by our company are used it could cause water leakage, electric shock, fire, and injury due to overturn of the unit. ⚠
- **Ventilate the working area well in case the refrigerant leaks during installation.**
If the refrigerant contacts the fire, toxic gas is produced. In case of R32, the refrigerant could be ignited because of its flammability. ⚠
- **Install the unit in a location that can hold heavy weight.**
Improper installation may cause the unit to fall leading to accidents. ⚠
- **Install the unit properly in order to be able to withstand strong winds such as typhoons, and earthquakes.**
Improper installation may cause the unit to fall leading to accidents. ⚠
- **Do not mix air in to the cooling cycle on installation or removal of the air-conditioner.**
If air is mixed in, the pressure in the cooling cycle will rise abnormally and may cause explosion and injuries. ⚠
- **Be sure to have the electrical wiring work done by qualified electrical installer, and use exclusive circuit.**
Power source with insufficient capacity and improper work can cause electric shock and fire. ⚠
- **Use specified wire for electrical wiring, fasten the wiring to the terminal securely, and hold the cable securely in order not to apply unexpected stress on the terminal.**
Loose connections or hold could result in abnormal heat generation or fire. ⚠
- **Arrange the electrical wires in the control box properly to prevent them from rising. Fit the lid of the services panel properly.**
Improper fitting may cause abnormal heat and fire. ⚠
- **Check for refrigerant gas leakage after installation is completed.**
If the refrigerant gas leaks into the house and comes in contact with a fan heater, a stove, or an oven, toxic gas is produced. ⚠
- **Use the specified pipe, flare nut, and tools for R32 or R410A.**
Using existing parts (R22) could cause the unit failure and serious accident due to explosion of the cooling cycle. ⚠
- **Tighten the flare nut according to the specified method by with torque wrench.**
If the flare nut were tightened with excess torque, it could cause burst and refrigerant leakage after a long period. ⚠
- **Do not put the drainage pipe directly into drainage channels where poisonous gases such as sulfide gas can occur.**
Poisonous gases will flow into the room through drainage pipe and seriously affect the user's health and safety. This can also cause the corrosion of the indoor unit and a resultant unit failure or refrigerant leak. ⚠
- **Connect the pipes for refrigeration circuit securely in installation work before compressor is operated.**
If the compressor is operated when the service valve is open without connecting the pipe, it could cause explosion and injuries due to abnormal high pressure in the system. ⚠
- **Stop the compressor before removing the pipe after shutting the service valve on pump down work.**
If the pipe is removed when the compressor is in operation with the service valve open, air would be mixed in the refrigeration circuit and it could cause explosion and injuries due to abnormal high pressure in the cooling cycle. ⚠
- **Only use prescribed option parts. The installation must be carried out by the qualified installer.**
If you install the system by yourself, it can cause serious trouble such as water leaks, electric shocks, fire. ⚠
- **Do not repair by yourself. And consult with the dealer about repair.**
Improper repair may cause water leakage, electric shock or fire. ⚠
- **Consult the dealer or a specialist about removal of the air-conditioner.**
Improper installation may cause water leakage, electric shock or fire. ⚠
- **Turn off the power source during servicing or inspection work.**
If the power is supplied during servicing or inspection work, it could cause electric shock and injury by the operating fan. ⚠
- **Do not run the unit when the panel or protection guard are taken off.**
Touching the rotating equipment, hot surface, or high voltage section could cause an injury to be caught in the machine, to get burned, or electric shock. ⚠
- **Shut off the power before electrical wiring work.**
It could cause electric shock, unit failure and improper running. ⚠

CAUTION

- **Perform earth wiring surely.**
Do not connect the earth wiring to the gas pipe, water pipe, lightning rod and telephone earth wiring. Improper earth could cause unit failure and electric shock or fire due to a short circuit. ⚠
- **Earth leakage breaker must be installed.**
If the earth leakage breaker is not installed, it could cause electric shocks or fire. ⚠
- **Use the circuit breaker of correct capacity. Circuit breaker should be the one that disconnect all poles under over current.**
Using the incorrect one could cause the system failure and fire. ⚠
- **Do not use any materials other than a fuse of correct capacity where a fuse should be used.**
Connecting the circuit by wire or copper wire could cause unit failure and fire. ⚠
- **Do not install the indoor unit near the location where there is possibility of flammable gas leakages.**
If the gas leaks and gathers around the unit, it could cause fire. ⚠
- **Do not install and use the unit where corrosive gas (such as sulfurous acid gas etc.) or flammable gas (such as thinner, petroleum etc.) may be generated or accumulated, or volatile flammable substances are handled.**
It could cause the corrosion of heat exchanger, breakage of plastic parts etc. And inflammable gas could cause fire. ⚠
- **Secure a space for installation, inspection and maintenance specified in the manual.**
Insufficient space can result in accident such as personal injury due to falling from the installation place. ⚠
- **Do not use the indoor unit at the place where water splashes such as laundry.**
Indoor unit is not waterproof. It could cause electric shock and fire. ⚠
- **Do not use the indoor unit for a special purpose such as food storage, cooling for precision instrument, preservation of animals, plants, and a work of art.**
It could cause the damage of the items. ⚠
- **Do not install nor use the system near equipments which generate electromagnetic wave or high harmonics.**
Equipments like inverter equipment, private power generator, high-frequency medical equipment, or telecommunication equipment might influence the air-conditioner and cause a malfunction and breakdown. Or the air-conditioner might influence medical equipments or telecommunication equipments, and obstruct their medical activity or cause jamming. ⚠
- **Do not install the remote control at the direct sunlight.**
It could cause breakdown or deformation of the remote control. ⚠
- **Do not install the indoor unit at the place listed below.**
 - Places where flammable gas could leak.
 - Places where carbon fiber, metal powder or any powder is floated.
 - Place where the substances which affect the air-conditioner are generated such as sulfide gas, chloride gas, acid, alkali or ammoniac atmospheres.
 - Places exposed to oil mist or steam directly.
 - On vehicles and ships
 - Places where machinery which generates high harmonics is used.
 - Places where cosmetics or special sprays are frequently used.
 - Highly salted area such as beach.
 - Heavy snow area
 - Places where the system is affected by smoke from a chimney.
 - Altitude over 1000m
- **Do not install the indoor unit in the locations listed below (Be sure to install the indoor unit according to the installation manual for each model because each indoor unit has each limitation)**
 - Locations with any obstacles which can prevent inlet and outlet air of the unit
 - Locations where vibration can be amplified due to insufficient strength of structure.
 - Locations where the infrared receiver is exposed to the direct sunlight or the strong light beam. (in case of the infrared specification unit)
 - Locations where an equipment affected by high harmonics is placed. (TV set or radio receiver is placed within 5m)
 - Locations where drainage cannot run off safely.
 - It can affect performance or function and etc.
 - Do not install the motion sensor at following places. It could cause deflection error, incapacity of detection, or characteristic degradation.
 - Place where vibration is applied to it for a long period of time.
 - Place where static electricity or electromagnetic wave generates.
 - Place where it is exposed to high temperature or humidity for a long period of time.
 - Dusty place or where the lens face could be fouled or damaged.
- **Do not put any valuables which will break down by getting wet under the air-conditioner.**
Condensation could drop when the relative humidity is higher than 80% or drain pipe is clogged, and it damages user's belongings. ⚠
- **Do not use the base frame for the outdoor unit which is corroded or damaged after a long period of use.**
It could cause the unit falling down and injury. ⚠
- **Pay attention not to damage the drain pan by weld sputter when brazing work is done near the unit.**
If sputter entered into the unit during brazing work, it could cause damage (pinhole) of drain pan and leakage of water. To avoid damaging, keep the indoor unit packed or cover the indoor unit. ⚠
- **Install the drain pipe to drain the water surely according to the installation manual.**
Improper connection of the drain pipe may cause dropping water into room and damaging user's belongings. ⚠
- **Do not share the drain pipe for indoor unit and GHP (Gas Heat Pump system) outdoor unit.**
Toxic exhaust gas would flow into room and it might cause serious damage (some poisoning or deficiency of oxygen) to user's health and safety. ⚠
- **Be sure to perform air tightness test by pressurizing with nitrogen gas after completed refrigerant piping work.**
If the density of refrigerant exceeds the limit in the event of refrigerant leakage in the small room, lack of oxygen can occur, which can cause serious accidents. ⚠
- **For drain pipe installation, be sure to make descending slope of greater than 1/100, not to make traps, and not to make air-bleeding.**
Check if the drainage is correctly done during commissioning and ensure the space for inspection and maintenance. ⚠
- **Ensure the insulation on the pipes for refrigeration circuit so as not to condense water.**
Incomplete insulation could cause condensation and it would wet ceiling, floor, and any other valuables. ⚠
- **Do not install the outdoor unit where is likely to be a nest for insects and small animals.**
Insects and small animals could come into the electronic components and cause breakdown and fire. Instruct the user to keep the surroundings clean. ⚠
- **Pay extra attention, carrying the unit by hand.**
Carry the unit with 2 people if it is heavier than 20kg. Do not use the plastic straps but the grabbing place, moving the unit by hand. Use protective gloves in order to avoid injury by the aluminum fin. ⚠
- **Make sure to dispose of the packaging material.**
Leaving the materials may cause injury as metals like nail and woods are used in the package. ⚠
- **Do not operate the system without the air filter.**
It may cause the breakdown of the system due to clogging of the heat exchanger. ⚠
- **Do not touch any button with wet hands.**
It could cause electric shock. ⚠
- **Do not touch the refrigerant piping with bare hands when in operation.**
The pipe during operation would become very hot or cold according to the operating condition, and it could cause a burn or frostbite. ⚠
- **Do not clean up the air-conditioner with water.**
It could cause electric shock. ⚠
- **Do not turn off the power source immediately after stopping the operation.**
Be sure to wait for more than 5 minutes. Otherwise it could cause water leakage or breakdown. ⚠
- **Do not control the operation with the circuit breaker.**
It could cause fire or water leakage. In addition, the fan may start operation unexpectedly and it may cause injury. ⚠

○ This model is high static ducted type air-conditioning unit. Therefore, do not use this model for direct blow type air-conditioning unit.

1 Before installation

- Install correctly according to the installation manual.
- Confirm the following points:
 - Unit type/Power source specification
 - Pipes/Wires/Small parts
 - Accessory items

Accessory item

For hanging		For refrigerant pipe				For drain pipe			Elbow (Multi only)
Flat washer (M10)	Pipe cover (big)	Pipe cover (small)	Strap	Pipe cover (big)	Pipe cover (small)	Drain hose	Hose clamp		
8	1	1	4	1	1	1	1	1	
For unit hanging	For heat insulation of gas pipe	For heat insulation of liquid tube	For pipe cover fixing	For heat insulation of drain socket	For heat insulation of drain socket	For drain pipe connecting	For drain hose mounting	For drain pipe connecting	

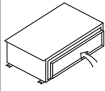

Accessory parts are stored inside this suction side.

2 Selection of installation location for the indoor unit

- Select the suitable areas to install the unit under approval of the user.
 - Areas where the indoor unit can deliver hot and cold wind sufficiently. Suggest to the user to use a circulator if the ceiling height is over 3m to avoid warm air being accumulated on the ceiling.
 - Areas where there is enough space to install and service.
 - Areas where it can be drained properly. Areas where drain pipe descending slope can be taken.
 - Areas where there is no obstruction of air flow on both air return grille and air supply port.
 - Areas where fire alarm will not be accidentally activated by the air-conditioner.
 - Areas where the supply air does not short-circuit.
 - Areas where it is not influenced by draft air.
 - Areas not exposed to direct sunlight.
 - Areas where dew point is lower than around 28°C and relative humidity is lower than 80%.

This indoor unit is tested under the condition of JIS (Japan Industrial Standard) high humidity condition and confirmed there is no problem. However, there is some risk of condensation drop if the air-conditioner is operated under the severer condition than mentioned above. If there is a possibility to use it under such a condition, attach additional insulation of 10 to 20mm thick for entire surface of indoor unit, refrigeration pipe and drain pipe.
 - Areas where TV and radio stays away more than 1m. (It could cause jamming and noise.)
 - Areas where any items which will be damaged by getting wet are not placed such as food, table wares, server, or medical equipment under the unit.
 - Areas where there is no influence by the heat which cookware generates.
 - Areas where not exposed to oil mist, powder and/or steam directly such as above fryer.
 - Areas where lighting device such as fluorescent light or incandescent light doesn't affect the operation.

(A beam from lighting device sometimes affects the infrared receiver for the wireless remote control and the air-conditioner might not work properly.)
- Check if the place where the air-conditioner is installed can hold the weight of the unit. If it is not able to hold, reinforce the structure with boards and beams strong enough to hold it. If the strength is not enough, it could cause injury due to unit falling.

Space for installation and service

- Make installation altitude over 2.5m. (Indoor Unit)
- Select either of two cases to keep space for installation and services.

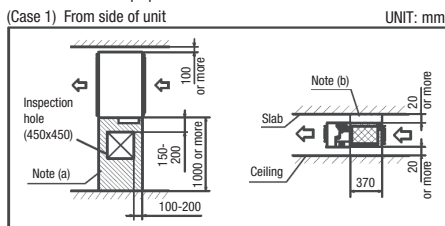

Notes (a) There must not be obstacle to draw out fan motor. (hatched) marked area) (b) Install refrigerant pipe, drain pipe, and wiring so as not to cross (cross-hatched) marked area.

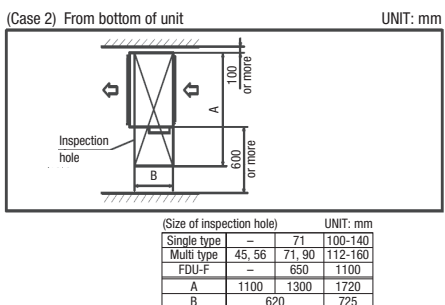

3 Cautions for the handling and installation place of outdoor air processing unit

- This unit monitors the outdoor air temperature at the position of sensor A in the figure, and controls the start and stop with the thermostat based on the value of sensor A and the setting temperature by the remote control.

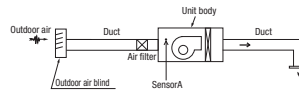

- Remote control's setting temperature indicates the outdoor air temperature that controls the start and stop of operation by the thermostat.
- When the thermostat is turned off, the operation is changed to the fan mode so that the outdoor air is blown out directly into the room. For example if the remote control is set to 22°C in cooling operation, and if the outdoor air temperature is 22°C or lower at that time, the unit will go into fan operation.
- When there is a difference between the air-conditioning temperature in the room during cooling operation and the temperature of air blown out from the outdoor air processing unit, dewing water may drip from the unit. To prevent the dewing, provide a sufficient heat insulation means at the air blow outlet.
 - Since the air blow outlet on the outdoor air processing unit may blow out the outdoor air directly, orient the outlet in such a way that it will not blow air directly to persons in the room.
 - Since the unit controls the thermostat start and stop by monitoring the outdoor air temperature, it is prohibited to monitor the room temperature by means of the room temperature monitoring by changing the thermostat setting at the remote control side and the option remote temperature sensor. Otherwise, dewing water may drip from the unit at lower outdoor air temperatures during cooling operation.
 - Install the remote control of the outdoor air processing unit at a place closer to the administrator to avoid the end user from using the remote control.
- When handing over the unit to the end user, make sure to explain sufficiently about the foregoing cautions, the installation place of the remote control for the outdoor air processing unit and the position of air blow outlet.

4 Preparation before installation

- If suspension bolt becomes longer, do reinforcement of earthquake resistant.
 - For grid ceiling
 - When the suspension bolt length is over 500mm, or the gap between the ceiling and roof is over 700mm, apply earthquake resistant brace to the bolt.
 - In case the unit is hanged directly from the slab and is installed on the ceiling plane which has enough strength.
 - When suspension bolt length is over 1000mm, apply the earthquake resistant brace to the bolt.
- Prepare four (4) sets of suspension bolt, nut and spring washer (M10) on site.

Suspension Bolt Location

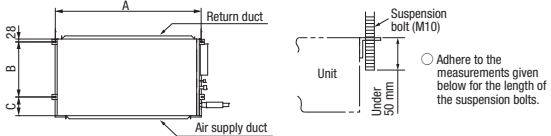

UNIT: mm			
Single type	-	71	100-140
Multi type	45, 56	71, 90	112-160
FDU-F	-	650	1100
A	786	986	1720
B	472	472	725
C	135	135	180

Pipe locations

Single type	71
Multi type	45-90
FDU-F	650

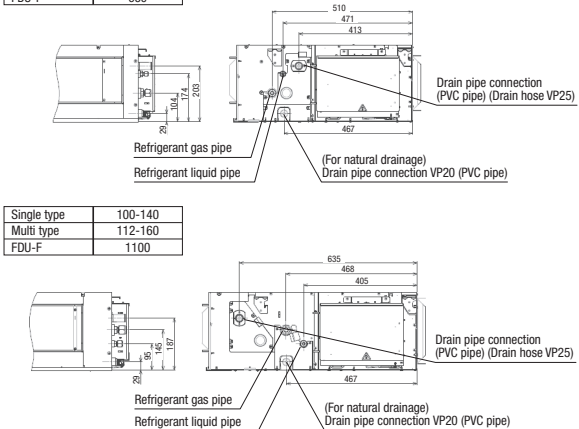

Single type	100-140
Multi type	112-160
FDU-F	1100

⑤ Installation of indoor unit

Work procedure

1. Prepare a hole of specified size on the ceiling.
2. Install suspension bolts at specified positions.
3. Make sure to use four suspension bolts.
4. Adjust the indoor unit position in order to fit with it.
5. Make sure to install the indoor unit horizontally. Confirm the levelness of the indoor unit with a level gauge or transparent hose filled with water. Keep the height difference at both ends of the indoor unit within 3mm.
6. Tighten four upper nuts and fix the unit after height and levelness adjustment.

Installation

[Hanging]

Hang the unit up.

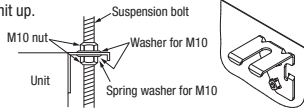

If the measurements between the unit and the ceiling hole do not match upon installation, it may be adjusted with the long holed installation tool.

Adjustment for horizontality

○ Either use a level vial, or adjust the level according to the method below.

- Adjust so the bottom side of the unit will be leveled with the water surface as illustrated below.

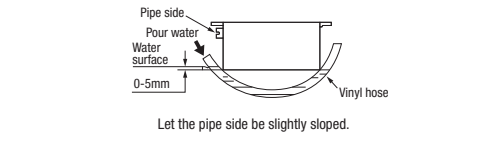

○ If the unit is not leveled, it may cause malfunctions or inoperation of the float switch.

⑥ Duct Work

- ① A corrugated board (for preventing spluttering) is attached to the main body of the air-conditioner (on the outlet port). Do not remove it until connecting the duct.

- An air filter can be provided on the main body of the air-conditioner (on the inlet port). Remove it when connecting the duct on the inlet port.

② Blowout duct

- Use rectangular duct to connect with unit.
- Duct size for each unit is as shown below.

		UNIT: mm		
Single type	—	71	100-140	
Multi type	45, 56	71, 90	112-160	
FDU-F	—	650	1100	
A	682	882	1202	
B	172	172	172	

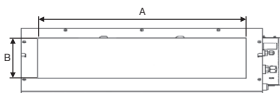

- Duct should be at their minimum length.
- We recommend to use sound and heat insulated duct to prevent it from condensation.
- Connect duct to unit before ceiling attachment.

③ Inlet port

- When connecting the duct to the inlet port, remove the air filter if it is fitted to the inlet port.
- Inlet port size for each unit is as shown below.

		UNIT: mm		
Single type	-	71	100-140	
Multi Type	45, 56	71, 90	112-160	
FDU-F	-	650	1100	
A	582	742	1282	
B	202	202	237	



- Make sure to insulate the duct to prevent dewing on it.

- ④ Install the specific blowout duct in a location where the air will circulate to the entire room.

- Conduct the installation of the specific blowout hole and the connection of the duct before attaching them to the ceiling.
- Insulate the area where the duct is secured by a band for dew condensation prevention.

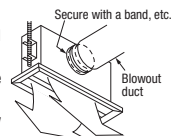

- ⑤ Make sure provide an inspection hole on the ceiling. It is indispensable to service electric equipment, motor, functional components and cleaning of heat exchanger.

⑥ Duct Work (continued)

- ⑥ Make sure to insulate ducts, in order to prevent dewing on them.

- ⑦ Connect the duct with care not to touch the blower (fan motor) with fingers. Or, when inhaling air directly from the suction side, install an air filter at the air suction inlet.

FDU

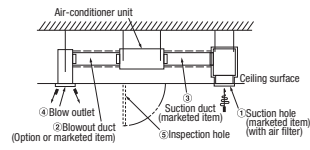

FDU-F

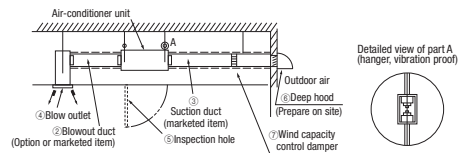

Bad example of duct work

- ① If a duct is not provided at the suction side but it is substituted with the space over the ceiling, humidity in the space will increase by the influence of capacity of ventilation fan, strength of wind blowing against the outdoor air louver, weather (rainy day) and others.
 - a) Moisture in air is likely to condense over the external plates of the unit and to drip on the ceiling. Unit should be operated under the conditions as listed in the above table and within the limitation of wind volume. When the building is a concrete structure, especially immediately after the construction, humidity tends to rise even if the space over the ceiling is not substituted in place of a duct. In such occasion, it is necessary to insulate the entire unit with glass wool (25mm). (Use a wire net or equivalent to hold the glass wool in place.)
 - b) It may run out the allowable limit of unit operation (Example, the case of FDU: When outdoor air temperature is 35°CDB, suction air temperature is 27°CWB) and it could result in such troubles as compressor overload, etc..
 - c) There is a possibility that the blow air volume may exceed the allowable range of operation due to the capacity of ventilation fan or strength of wind blowing against external air louver so that drainage from be heat exchanger may fall to reach the drain pan but leak outside (Example: drip on to the ceiling) with consequential water leakage in the room.
- ② If vibration damping is not conducted between the unit and the duct, and between the unit and the slab, vibration will be transmitted to the duct and vibration noise may occur. Also, vibration may be transmitted from the unit to the slab. Vibration damping must be performed.

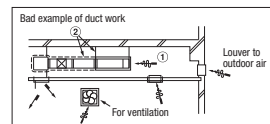

Connecting the air intake/vent ducts the case of FDU

- ① Fresh Air Intake [for air intake duct only]
 - Use the side fresh air intake hole, or supply through a part of the suction duct.

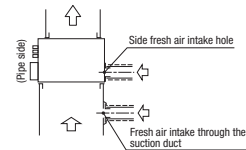

- [for simultaneous air intake/vent]
- Intake air through the suction duct. (the side cannot be used)

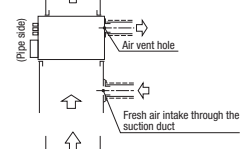

- ② Air Vent
 - Use the side air vent hole. (always use together with the air intake)

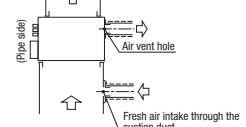

- Insulate the duct to protect it from dew condensation.

⑦ Refrigerant pipe

Caution

- Be sure to use new pipes for the refrigerant pipes. Use the flare nut attached to the product. Regarding whether existing pipes can be reused or not, and the washing method, refer to the instruction manual of the outdoor unit, catalogue or technical data.
 - 1) In case of reuse: Do not use old flare nut, but use the one attached to the unit.
 - 2) In case of reuse: Flare the end of pipe replaced partially for R32 or R410A.

⚠ WARNING : When flared joints are reused indoors, the flare part shall be re-fabricated. (only for R32)

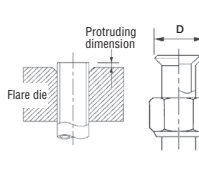

Pipe dia. d mm	Min. pipe wall thickness mm	Protruding dimension for flare, mm		Flare O.D. D mm	Flare nut tightening torque N·m
		Rigid (Clutch type) For R32 For R410A	Conventional bot		
6.35	0.8	0 - 0.5	0.7 - 1.3	8.9 - 9.1	14 - 18
9.52	0.8			12.8 - 13.2	34 - 42
12.7	0.8			16.2 - 16.6	49 - 61
15.88	1			19.3 - 19.7	68 - 82
19.05	1.2			23.6 - 24.0	100 - 120

- Use phosphorus deoxidized copper alloy seamless pipe (C1220T) for refrigeration pipe installation. In addition, make sure there is no damage both inside and outside of the pipe, and no harmful substances such as sulfur, oxide, dust or a contaminant stuck on the pipes.
- Do not use any refrigerant other than R32 or R410A. Using other refrigerant except R32 or R410A (R22 etc.) may degrade inside refrigeration oil. And air getting into refrigeration circuit may cause over-pressure and resultant it may result in bursting, etc.
- Store the copper pipes indoors and seal the both end of them until they are brazed in order to avoid any dust, dirt or water getting into pipe. Otherwise it will cause degradation of refrigeration oil and compressor breakdown, etc.
- Use special tools for R32 or R410A refrigerant.

Piping work

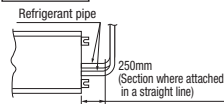

When conducting piping work, make sure to allow the pipes to be aligned in a straight line for at least 250 mm, as shown in the left illustration. (This is necessary for the drain pump to function)

Work procedure

1. Remove the flare nut and blind flanges on the pipe of the indoor unit.
 - ※ Make sure to loosen the flare nut with holding the nut on pipe side with a spanner and giving torque to the nut with another spanner in order to avoid unexpected stress to the copper pipe, and then remove them. (Gas may come out at this time, but it is not abnormal.)
 - Pay attention whether the flare nut pops out. (as the indoor unit is sometimes pressured.)
2. Make a flare on liquid pipe and gas pipe, and connect the refrigeration pipes on the indoor unit.
 - ※ Bend radius of pipe must be 4D or larger. Once a pipe is bent, do not readjust the bending. Do not twist a pipe or collapse to 2/3D or smaller.
 - Make sure to use flare nuts assembled on the unions. Usage of other flare nuts could cause refrigerant leakage.
 - ※ Do a flare connection as follows:
 - Make sure to hold the nut on indoor unit pipe side using double spanner method as indicated when fastening / loosening flare nuts in order to prevent unintentional twisting of the copper pipe.
 - When fastening the flare nut, align the refrigeration pipe with the center of flare nut, screw the nut for 3-4 times by hand and then tighten it by spanner with the specified torque mentioned in the table above.
3. Cover the flare connection part of the indoor unit with attached insulation material after a gas leakage inspection, and tighten both ends with attached straps.
 - Make sure to insulate both gas pipes and liquid pipes completely.
 - ※ Incomplete insulation may cause dew condensation or water dropping.
 - Use heat-resistant (120 °C or more) insulations on the gas side pipes.
 - In case of using at high humidity condition, reinforce insulation of refrigerant pipes. Surface of insulation may cause dew condition or water dropping, if insulations are not reinforced.
4. Refrigerant is charged in the outdoor unit. As for the additional refrigerant charge for the indoor unit and piping, refer to the installation manual attached to the outdoor unit.

Caution:

Refrigerating machine oil should not be applied to the threads of union or external surface of flare. It is because, even if the same tightening torque is applied, the oil is likely to decrease the slide friction force on the threads and increase, in turn, the axial component force so that it could crack the flare by the stress corrosion. Refrigerating machine oil may be applied to the internal surface of flare only.

<The case of using thickness of insulation is 10mm>

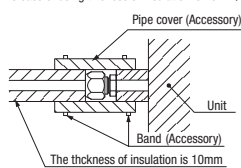

<The case of using reinforced insulation>

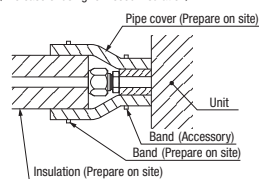

⑧ Drain pipe

Caution

- Install the drain pipe according to the installation manual in order to drain properly. Imperfection in draining may cause flood indoors and wetting the household goods, etc.
- Do not put the drain pipe directly into the ditch where toxic gas such as sulfur, the other harmful and inflammable gas is generated. Toxic gas would flow into the room and it would cause serious damage to user's health and safety (some poisoning or deficiency of oxygen). In addition, it may cause corrosion of heat exchanger and bad smell.
- Connect the pipe securely to avoid water leakage from the joint.
- Insulate the pipe properly to avoid condensation drop.
- Check if the water can flow out properly from both the drain outlet on the indoor unit and the end of the drain pipe after installation.
- Make sure to make descending slope of greater than 1/100 and do not make up-down bend and/or trap in the midway. In addition, do not put air vent on the drain pipe. Check if water is drained out properly from the pipe during commissioning. Also, keep sufficient space for inspection and maintenance.

Work procedure

1. Make sure to insert the drain hose (the end made of soft PVC) to the end of the step part of drain socket. Attach the hose clamp to the drain hose around 10mm from the end, and fasten the screw about 5mm left to the nut.
 - Do not apply adhesives on this end.
 - Do not use acetone-based adhesives to connect to the drain socket.

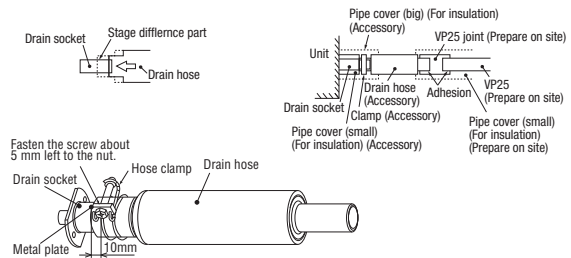

2. Prepare a joint for connecting VP25 pipe, adhere and connect the joint to the drain hose (the end made of rigid PVC), and adhere and connect VP25 pipe (prepare on site).
 - ※ As for drain pipe, apply VP25 made of rigid PVC which is on the market.
 - Make sure that the adhesive will not get into the supplied drain hose. It may cause the flexible part broken after the adhesive is dried up and gets rigid.
 - The flexible drain hose is intended to absorb a small difference at installation of the unit or drain pipes. Intentional bending, expanding may cause the flexible hose broken and water leakage.

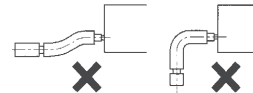

- As for drain pipe, apply VP25 (OD32). If apply PVC25 (OD25), connect the expanded connector to the drain hose, with adhesive. (Multi unit only)

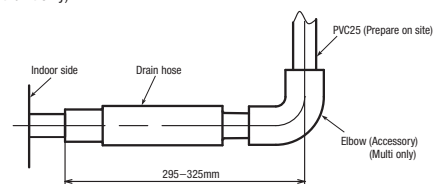

3. Make sure to make descending slope of greater than 1/100 and do not make up-down bend and/or trap in the midway.
 - Pay attention not to give stress on the pipe on the indoor unit side, and support and fix the pipe as close place to the unit as possible when connecting the drain pipe.
 - Do not set up air vent.

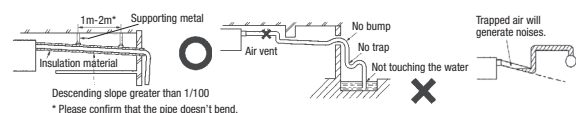

- When sharing a drain pipe for more than one unit, lay the main pipe 100mm below the drain outlet of the unit. In addition, select VP30 or bigger size for main drain pipe.

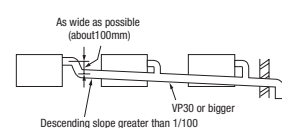

⑧ Drain pipe (continued)

4. Insulate the drain pipe.
 - Be sure to insulate the drain socket and rigid PVC pipe installed indoors otherwise it may cause dew condensation and water leakage.
 - ※ After drainage test implementation, cover the drain socket part with pipe cover (small size), then use the pipe cover (big size) to cover the pipe cover (small size), clamps and part of the drain hose, and fix and wrap it with tapes to wrap and make joint part gapless.

Drain up

- The position for drain pipe outlet can be raised up to 600mm above the ceiling. Use elbows for installation to avoid obstacles inside ceiling. If the horizontal drain pipe is too long before vertical pipe, the backflow of water will increase when the unit is stopped, and it may cause overflow of water from the drain pan on the indoor unit. In order to avoid overflow, keep the horizontal pipe length and offset of the pipe within the limit shown in the figure below.

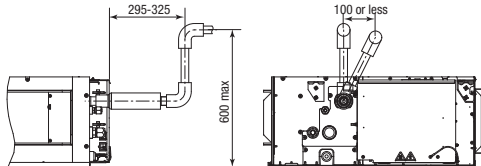

Otherwise, the construction point makes it same as drain pipe construction.

Drain test

1. Conduct a drain test after completion of the electrical work.
2. During the trial, make sure that drain flows properly through the piping and that no water leaks from connections.
3. In case of a new building, conduct the test before it is furnished with the ceiling.
4. Be sure to conduct this test even when the unit is installed in the heating season.

Procedures

1. Supply about 2000 cc of water to the unit through the air outlet by using a feed water pump.
2. Check the drain while cooling operation.

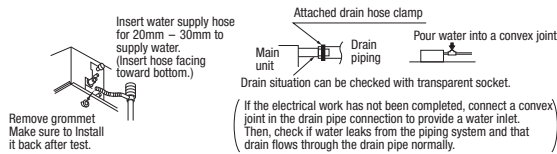

Outline of bottom drain piping work

- If the bottom drain piping can be done with a descending gradient (1/50-1/100), it is possible to connect the pipes as shown in the drawing below.

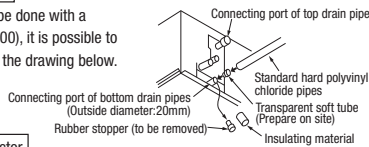

Uncoupling the drain motor connector

- Uncouple the connector CnR for the drain motor as illustrated in the drawing on the right.

(Note: If the unit is run with the connector coupled, drain water will be discharged from the upper drain pipe joint, causing a water leak.)

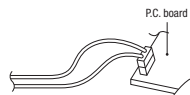

⑨ Wiring-out position and wiring connection

- Electrical installation work must be performed according to the installation manual by an electrical installation service provider qualified by a power provider of the country, and be executed according to the technical standards and other regulations applicable to electrical installation in the country. Be sure to use an exclusive circuit.
 - Use specified cord, fasten the wiring to the terminal securely, and hold the cord securely in order not to apply unexpected stress on the terminal.
 - Do not put both power source line and signal line on the same route. It may cause miscommunication and malfunction.
 - Be sure to do D type earth work.
 - For the details of electrical wiring work, see attached instruction manual for electrical wiring work.
1. Remove a lid of the control box (2 screws).
 2. Hold each wiring inside the unit and fasten them to terminal block securely.
 3. Fix the wiring with clamps.
 4. Install the removed parts back to original place.

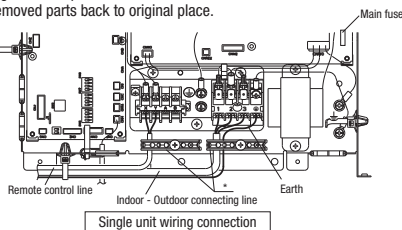

Single unit wiring connection

⑨ Wiring-out position and wiring connection (continued)

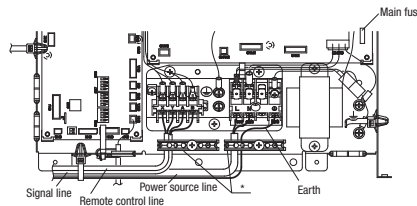

Multi unit wiring connection

Main fuse specification

Model	FDU-F	Specification	Part No.
45-90	650	T 5A L 250V	SSA564A149AH
112-160	1100	T 6.3A L 250V	SSA564A149AJ

* Please fix the wiring in the band not to move even if it pulls.

⑩ External static pressure setting

You can set External Static Pressure (E.S.P.) by method of MANUAL SETTING on remote control. Indoor unit will control fan-speed to keep rated air flow volume at each fan speed setting (Lo-P-Hi). You can set required E.S.P. by wired remote control that calculated with the set air flow rate and pressure loss of the duct connected.

- How to set E.S.P. by wired remote control
 - ① Push "◆" marked button (E.S.P. button).
 - ② Select indoor unit No. by using "◆" button.
 - ③ Select setting No. by using "◆" button and set E.S.P. by "□" button.



Notice

You can not set E.S.P. by wireless remote control.

With E.S.P. setting, confirm that actual E.S.P. agrees with E.S.P. setting. When E.S.P. setting is higher than actual E.S.P., the air flow rate becomes excessively higher. This will cause water leakage if water splashes. When E.S.P. setting is lower than actual E.S.P., the air flow rate becomes excessively lower and the cooling or heating may become ineffective. In order to reduce the risk above the factory E.S.P. setting is set within the range of 80 – 150 Pa (E.S.P. setting No. 8 – 15). Be sure to use within the range of 80 – 150 Pa in actual operations. If actual E.S.P. is lower than 80 Pa, it may cause water leakage.

Setting No.	8	9	10	11	12	13	14	15
E.S.P. (Pa)	80	90	100	110	120	130	140	150

- ※ If 1 – 7 is selected for the setting No. on the remote control, the setting No. shows No. 8.
- ※ If 16 – 20 is selected for the setting No. on the remote control, the setting No. shows No. 15.
- ※ Factory default is No. 8.

The Case of FDU-F

Setting No.	1	2	3	4	5	6	7	8	9	10	11	12
E.S.P. (Pa)	10	20	30	40	50	60	70	80	90	100	110	120

- ※ If 13-20 is selected for the setting No. on the remote control, the setting No. shows No. 12.
- ※ Factory default is No. 8.

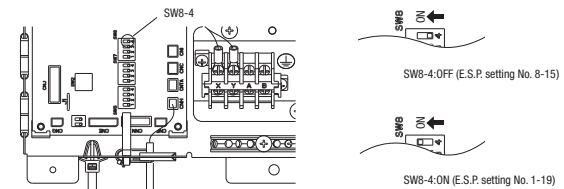

If SW8-4 is turned to "ON", E.S.P. setting range can be changed to 10 – 200 Pa (E.S.P. setting No. 1 – 19). This should not be used when actual E.S.P. cannot be confirmed, because the risk above becomes higher.

Setting No.	1	2	3	4	5	6	7	8	9	10	11	12	13	14	15	16	17	18	19
E.S.P. (Pa)	10	20	30	40	50	60	70	80	90	100	110	120	130	140	150	160	170	180	200

- ※ If 20 is selected for the setting No. on the remote control, the setting No. shows No. 19.

⑪ Check list after installation

- Check the following items after all installation work completed.

Check if	Expected trouble	Check
The indoor and outdoor units are fixed securely?	Falling, vibration, noise	Check
Inspection for leakage is done?	Insufficient capacity	
Insulation work is properly done?	Water leakage	
Water is drained properly?	Water leakage	
Power source voltage is same as mentioned in the model name plate?	PCB burnt out, not working at all	
No mis-wiring or mis-connection of piping?	PCB burnt out, not working at all	
Earth wiring is connected properly?	Electric shock	
Cable size comply with specified size?	PCB burnt out, not working at all	
Any obstacle blocks air flow on air inlet and outlet?	Insufficient capacity	
Is setting of E.S.P. finished?	Excessive air flow, water drop blow out	

(b) Replacement procedure of the fan unit

- Notes(1) The unit is a heavy item. It must be supported securely and handled with care not to drop when it is necessary to replace.
 (2) For the maintenance space, refer to page 171.

Models FDU100VH, 125VH, 140VH

- (i) Remove the control box and the side panel, and remove the screws marked in the circles (2 places) from the unit located at the near side.

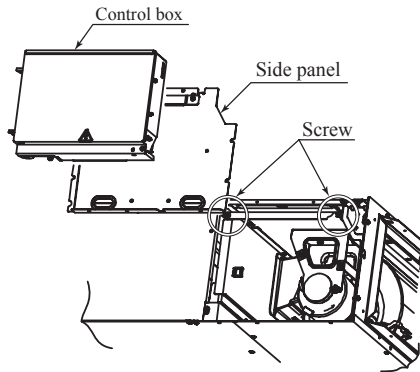

- (ii) Take out the fan unit located at the near side in the arrow direction.

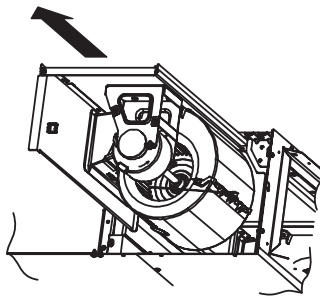

- (iii) Remove the screws marked in the circles (2 places) from the fan unit located at the far side.

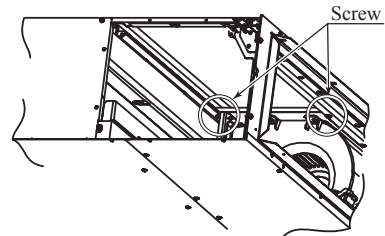

- (iv) Take out the fan unit in the arrow direction.

